

Altronic Service Bulletin #522

ISSUED: 12/30/19

ModBus Connection

**BB-USOPTL4-LS, USB to RS-422/485 Converter
(Isolated, Locked Serial Number)**

Altronic P/N 691210-1



1. Install Drivers:

Use the included CD to install the converter's drivers; or download drivers from www.bb-elec.com.

Warning: To prevent installation errors, do not plug in the hardware before drivers have been installed.

After connecting the device, check the Device Manager to learn which COM port number was assigned (Control Panel/System/Hardware/Device Manager/Ports LPT & COM)

COM numbers may be re-assigned by clicking the Advanced Settings button on the Port Settings screen.

2. Set DIP Switches:

DIP SWITCH POSITION	
Switch	ON (right)
1	TD Only Enabled During Data Transmission (RS-485)
2	RD Disabled During Data Transmission (ECHO Off)
3	2-Wire Mode
4	2-Wire Mode

3. Wire the Converter:

2-Wire RS-485 (half-duplex)

+ All DIP Switches = On

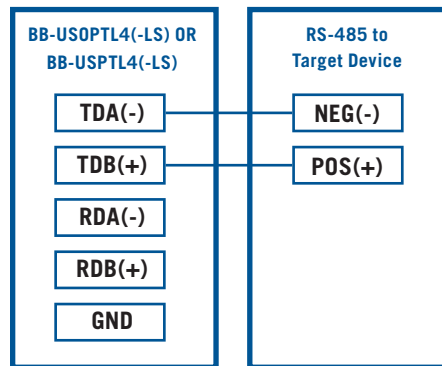

4. Check LEDs:

Use the TX LED to verify that terminal program is talking to the USB converter. Check selected ComPort and Drivers.

If TX is blinking with no RX response, check target connection, BaudRate and NodeID.

NOTE: This convertor does not work for CPU-2000 or CPU-95 direct connections.